

**FEUIL1803**

02.2025

## Sanifos

- FR** • Feuillet technique
- EN** • Data booklet
- DE** • Datenheft
- ES** • Ficha de datos técnicos
- IT** • Scheda tecnica
- NL** • Technische gegevensblad
- PT** • Ficha de dados técnicos
- PL** • Arkusz danych technicznych
- NO** • Teknisk datablad
- RO** • Broşura de date
- HU** • Műszaki adatlap
- VI** • Thông tin kỹ thuật

# SANIFOS 110



Étendue de la fourniture - Scope of supply- Lieferumfang - Elementes suministrados - Oggetto della fornitura - Âmbito do fornecimento - Leveringsomvang - Zakres dostawy - Leveransens innehåll - Lista de piese furnizate - A szállított alkatrészek listája - Kiện hàng

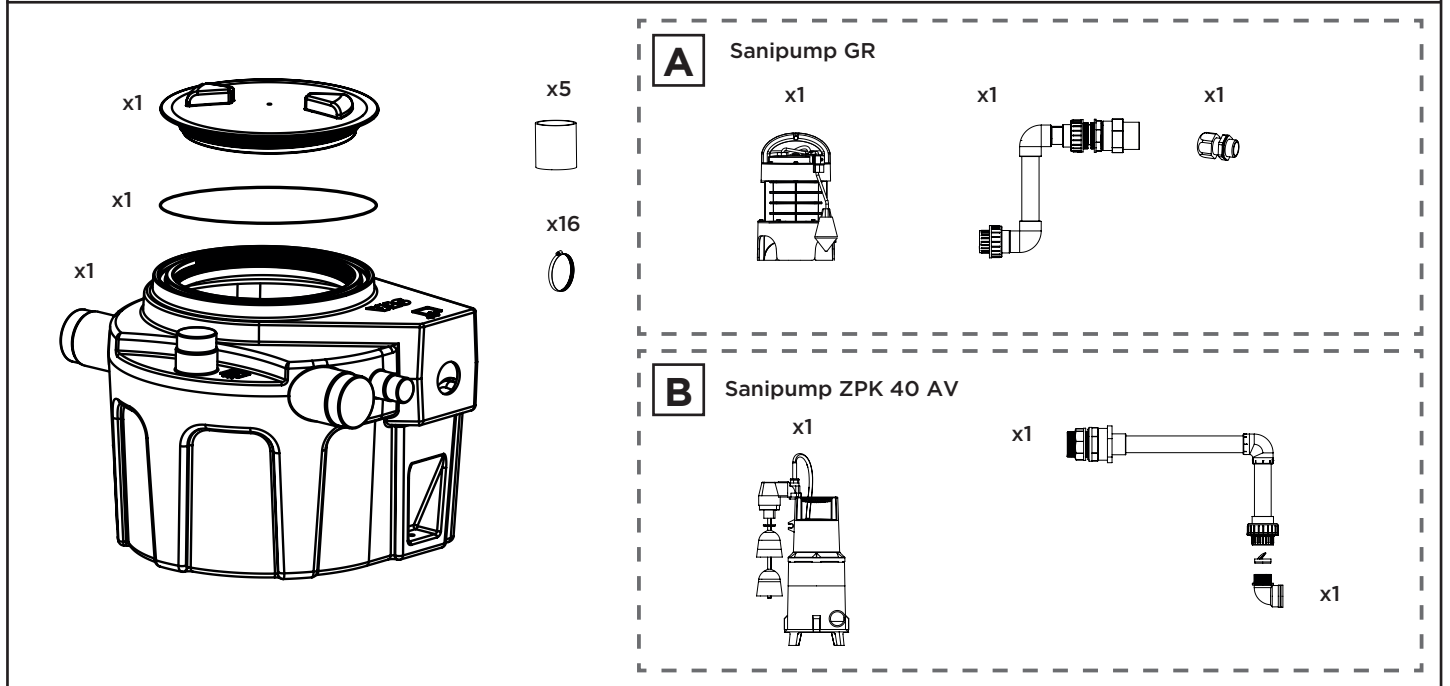

Caractéristiques techniques - Technical data - Technische Daten - Datos técnicos - Caratteristiche tecniche - Dados técnicos - Technische gegevens - Technické údaje - Informacje techniczne - Tehniska data - Date tehnice - Műszaki adatok - Thông số kỹ thuật

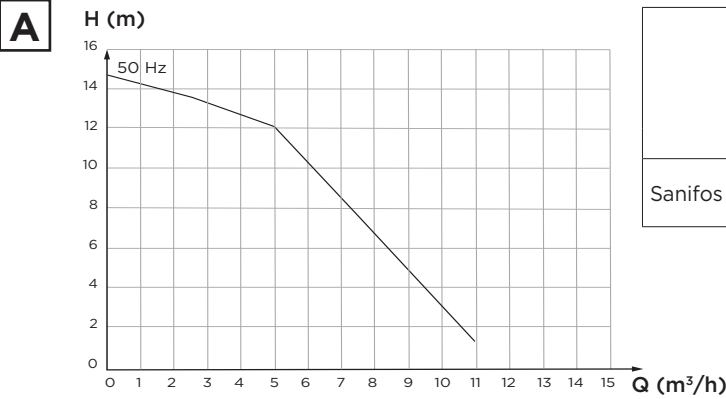

|                       | ~<br>(V) | P 1<br>(W) | Q max<br>(m³/h) | H max<br>(m) | I<br>(A) | (kg) | (mm) ±10 mm |
|-----------------------|----------|------------|-----------------|--------------|----------|------|-------------|
|                       |          |            |                 |              |          |      | OFF ON      |
| Sanifos 110 1 GR SP S | 1-230    | 1500       | 15              | 14           | 6        | 40   | 120 320     |

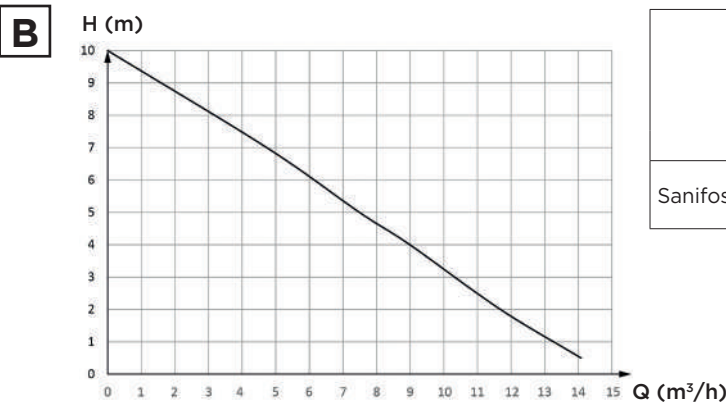

|                       | ~<br>(V) | P 1<br>(W) | Q max<br>(m³/h) | H max<br>(m) | I<br>(A) | (kg) | (mm) ±10 mm     |
|-----------------------|----------|------------|-----------------|--------------|----------|------|-----------------|
|                       |          |            |                 |              |          |      | OFF ON          |
| Sanifos 110 ZPK 40 AV | 1-230    | 850        | 14              | 10           | 3,7      | 33,6 | 100-180 200-240 |

# SANIFOS 280

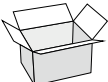
 **Étendue de la fourniture - Scope of supply- Lieferumfang - Elementes suministrados - Oggetto della fornitura - Âmbito do fornecimento - Leveringsomvang - Zakres dostawy - Leveransens innehåll - Lista de piese furnizate - A szállított alkatrészek listája - Kiện hàng**

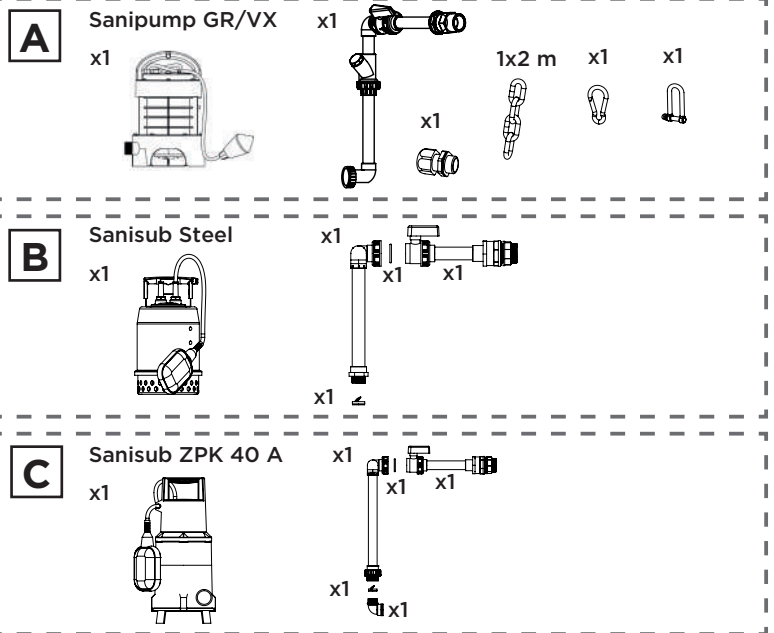
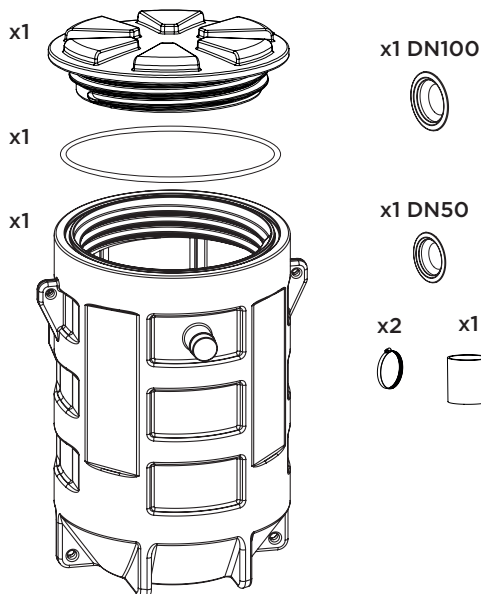

**Caractéristiques techniques - Technical data - Technische Daten - Datos técnicos - Caratteristiche tecniche - Dados técnicos - Technische gegevens - Technické údaje - Informacje techniczne - Tehniska data - Date tehnice - Műszaki adatok - Thông số kỹ thuật**

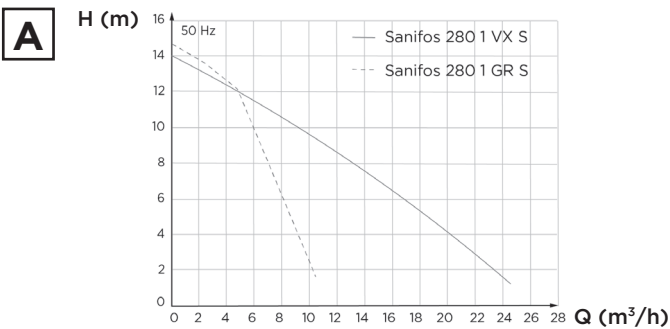

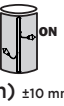
|                       | ~<br>(V) | P 1<br>(W) | Q max<br>(m³/h) | H max<br>(m) | I<br>(A) | Kg<br>(kg) |  OFF ON<br>(mm) ±10 mm |     |
|-----------------------|----------|------------|-----------------|--------------|----------|------------|---|-----|
|                       |          |            |                 |              |          |            | OFF   | ON  |
| Sanifos 280 1 GR SP S | 1-230    | 1500       | 15              | 14           | 6        | 55         | 120   | 320 |
| Sanifos 280 1 VX SP S | 1-230    | 1500       | 26              | 13           | 6        | 55         | 140   | 340 |

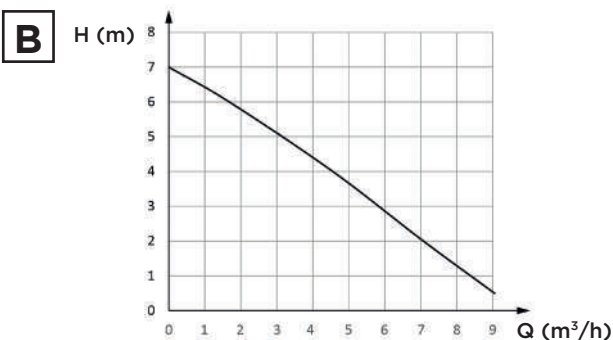

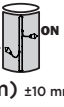
|                   | ~<br>(V) | P 1<br>(W) | Q max<br>(m³/h) | H max<br>(m) | I<br>(A) | Kg<br>(kg) |  OFF ON<br>(mm) ±10 mm |     |
|-------------------|----------|------------|-----------------|--------------|----------|------------|---|-----|
|                   |          |            |                 |              |          |            | OFF   | ON  |
| Sanifos 280 Steel | 1-230    | 450        | 9               | 7            | 2        | 46,5       | 110   | 360 |

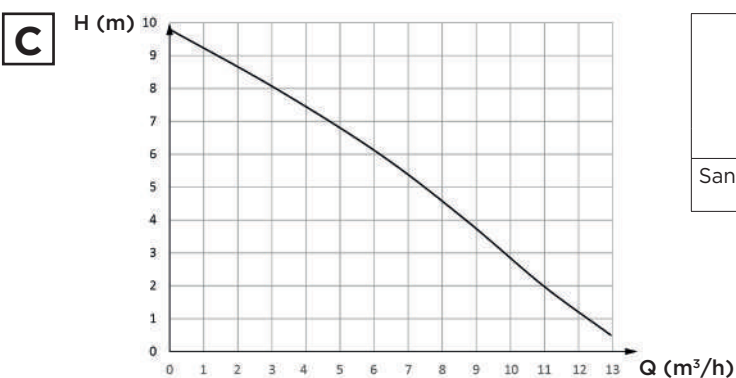

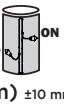
|                      | ~<br>(V) | P 1<br>(W) | Q max<br>(m³/h) | H max<br>(m) | I<br>(A) | Kg<br>(kg) |  OFF ON<br>(mm) ±10 mm |     |
|----------------------|----------|------------|-----------------|--------------|----------|------------|---|-----|
|                      |          |            |                 |              |          |            | OFF   | ON  |
| Sanifos 280 ZPK 40 A | 1-230    | 850        | 13              | 10           | 3,7      | 48,6       | 250   | 400 |

# SANIFOS 390

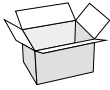

Étendue de la fourniture - Scope of supply - Lieferumfang - Elementes suministrados - Oggetto della fornitura - Âmbito do fornecimento - Leveringsomvang - Zakres dostawy - Leveransens innehåll - Lista de piese furnizate - A szállított alkatrészek listája - Kiện hàng

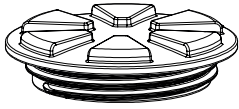

x1



x1

x1 DN100



x1 DN75



x1 DN50

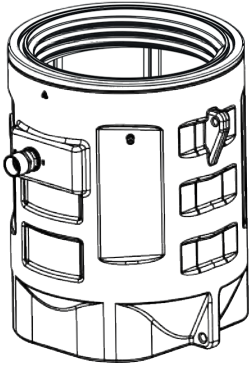

x1

+ hydraulique pré-montée, flotteur(s) - pre-assembled hydraulic, float(s) - vormontierte Hydraulik, Schwimmer(n) - Accesorios hidráulicos preinstalados, flotador(es) - Sistema hidráulico pré-montado, flutuador(es) - Hydraulica voorgemonteerd, vlotter - Idraulica premontata, galleggiante(i)

**A**

Sanipump GR/VX

x1

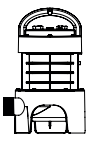

x1

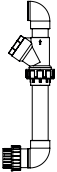

1x 2m



x1



x1



x1



x1



x1



x1



**B**

Sanipump GR/VX

x2

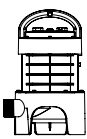

x2

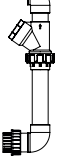

1x 2m



x1



x2



x1



x2 RD : x3



x3 RD : x1



3xPG11, 2xPG13 RD : 1xPG11, 3xPG13



x1



x1

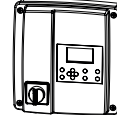

RD

x1



x1



**C**

Sanipump SLD

x1



x1



1x 2m



x1



x1



x1



x1



x1



**D**

Sanipump SLD

x2



x2



1x 2m



x1



x2



x1



x2 RD : x3



x3 RD : x1



3xPG11, 2xPG13 RD : 1xPG11, 3xPG13



x1



x1



RD

x1



x1





Caractéristiques techniques - Technical data - Technische Daten - Datos técnicos - Caratteristiche tecniche - Dados técnicos - Technische gegevens - Technické údaje - Informacje techniczne - Tehniska data - Date tehnice - Műszaki adatok - Thông số kỹ thuật

**A B**

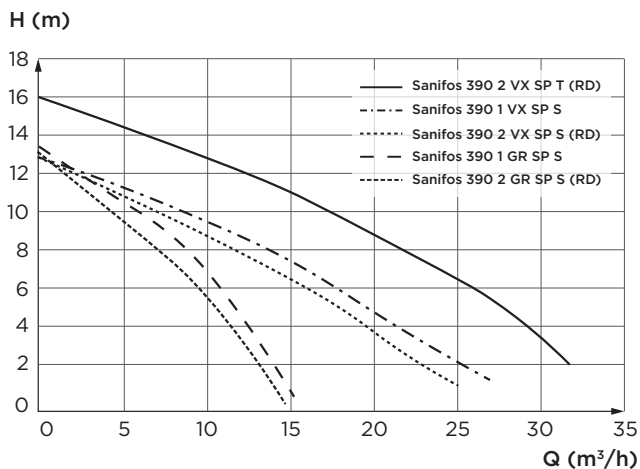

|                          | ~<br>(V)  | P 1<br>(W) | Q max<br>(m³/h) | H max<br>(m) | I<br>(A) | Kg<br>(kg) | Niveau - Level - Stand-<br>Nivel - Livello - Nivel<br>(mm) ±10 mm |     |
|--------------------------|-----------|------------|-----------------|--------------|----------|------------|---|-----|
|                          |           |            |                 |              |          |            | OFF   | ON  |
| Sanifos 390 1 GR SP S    | 1-<br>230 | 1500       | 15              | 13           | 6        | 45         | 170   | 350 |
| Sanifos 390 1 VX SP S    | 1-<br>230 | 1500       | 27              | 13           | 6        | 50         | 180   | 360 |
| Sanifos 390 2 GR SP S    | 1-<br>230 | 1500       | 15              | 13           | 6        | 65         | 90*   | 390 |
| Sanifos 390 2 GR SP S RD |           |            |                 |              |          |            | 160   | 400 |
| Sanifos 390 2 VX SP S    | 1-<br>230 | 1500       | 25              | 13           | 6        | 70         | 160   | 390 |
| Sanifos 390 2 VX SP S RD |           |            |                 |              |          |            | 160   | 400 |
| Sanifos 390 2 VX SP T    | 3-<br>400 | 2800       | 32              | 16           | 6        | 70         | 160   | 390 |
| Sanifos 390 2 VX SP T RD |           |            |                 |              |          |            | 160   | 400 |

**C D**

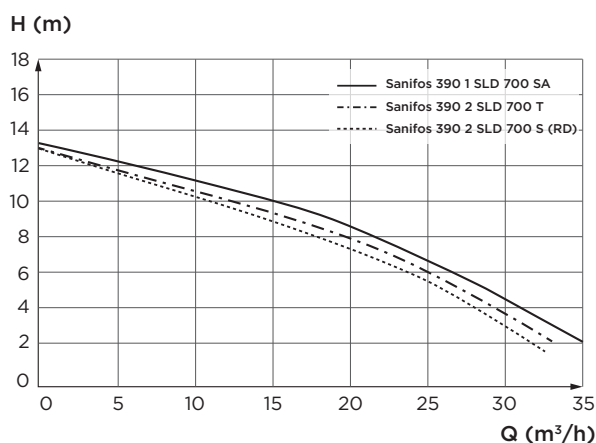

|                            | ~<br>(V)  | P 1<br>(W) | Q max<br>(m³/h) | H max<br>(m) | I<br>(A) | Kg<br>(kg) | Niveau - Level - Stand-<br>Nivel - Livello - Nivel<br>(mm) ±10 mm |     |
|----------------------------|-----------|------------|-----------------|--------------|----------|------------|---|-----|
|                            |           |            |                 |              |          |            | OFF   | ON  |
| Sanifos 390 1 SLD 700 SA   | 1-<br>230 | 2000       | 35              | 13           | 9,2      | 70         | 140 min.  | 500 |
| Sanifos 390 2 SLD 700 S    | 1-<br>230 | 2000       | 32              | 13           | 9,2      | 110        | 180   | 400 |
| Sanifos 390 2 SLD 700 S RD |           |            |                 |              |          |            | 160   | 400 |
| Sanifos 390 2 SLD 700 T    | 3-<br>400 | 2000       | 33              | 13           | 3,3      | 110        | 180   | 400 |
| Sanifos 390 2 SLD 700 T RD |           |            |                 |              |          |            | 160   | 400 |

\* avec délai retard, with stop delay, mit Pumpennachlaufzeit, con tiempo de retraso, con tempo di ritardo, met pompvertraging, com tempo de atraso

# SANIFOS 610

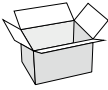

Étendue de la fourniture - Scope of supply- Lieferumfang - Elementes suministrados - Oggetto della fornitura - Âmbito do fornecimento - Leveringsomvang - Zakres dostawy - Leveransens innehåll - Lista de piese furnizate - A szállított alkatrészek listája - Kiện hàng

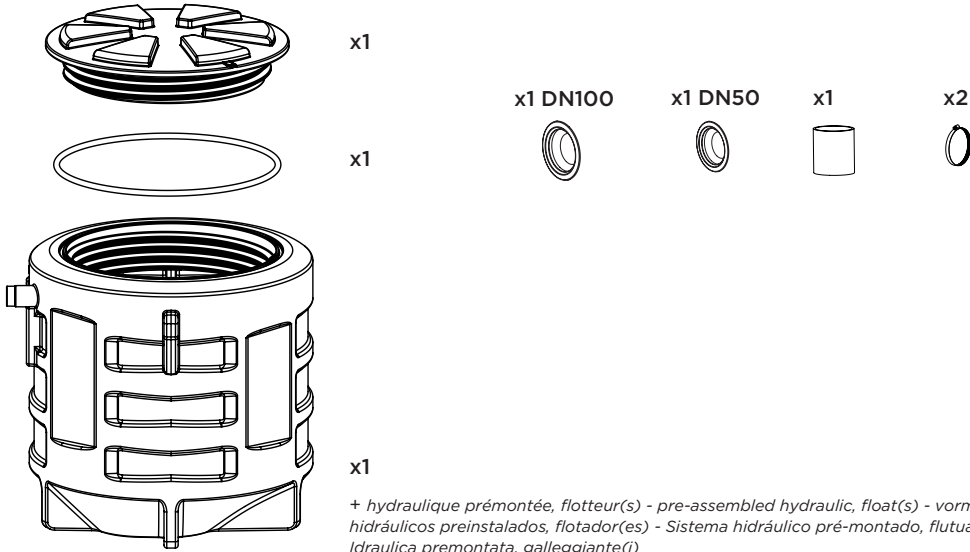

**A**

Sanipump GR/VX

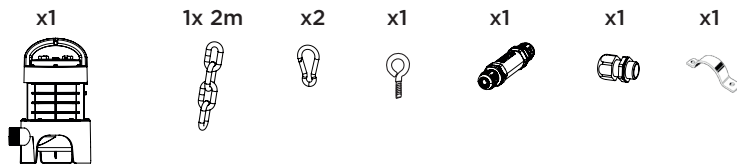

**B**

Sanipump GR/VX

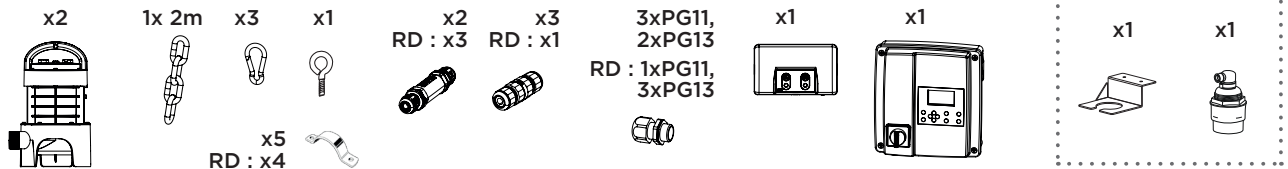

**C**

Sanipump SLD

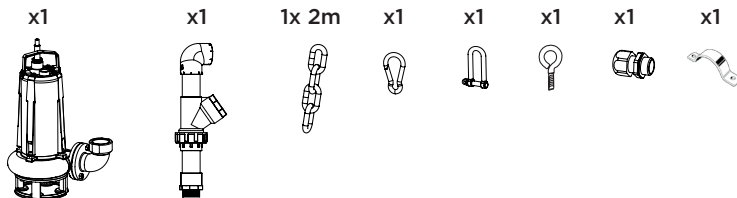

**D**

Sanipump SLD

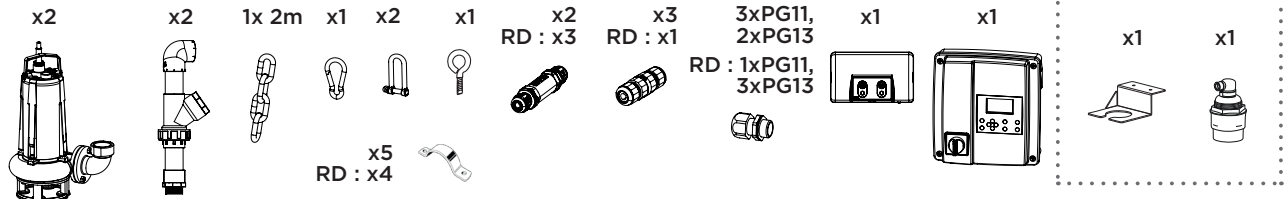



Caractéristiques techniques - Technical data - Technische Daten - Datos técnicos - Caratteristiche tecniche - Dados técnicos - Technische gegevens - Technické údaje - Informacje techniczne - Tehniska data - Date tehnice - Műszaki adatok - Thông số kỹ thuật

**A B**

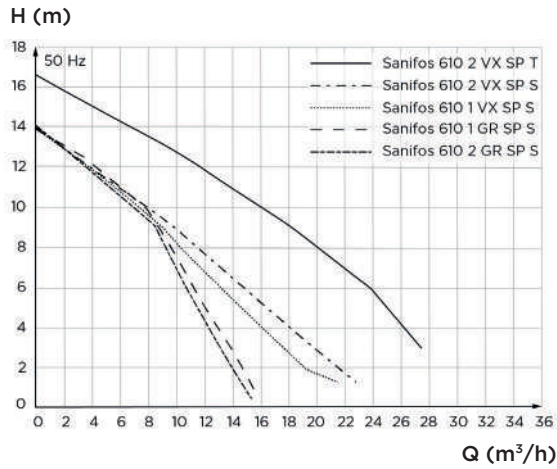

|                          | ~<br>(V)  | P 1<br>(W) | Q max<br>(m³/h) | H max<br>(m) | I<br>(A) | <br>(kg) | Niveau - Level - Stand-<br>Nivel - Livello - Nivel<br>(mm) ±10 mm |     |
|--------------------------|-----------|------------|-----------------|--------------|----------|--|---|-----|
|                          |           |            |                 |              |          |  | OFF   | ON  |
| Sanifos 610 1 GR SP S    | 1-<br>230 | 1500       | 16              | 14           | 6        | 100  | 140   | 340 |
| Sanifos 610 1 VX SP S    | 1-<br>230 | 1500       | 21              | 14           | 6        | 100  | 160   | 360 |
| Sanifos 610 2 GR SP S    | 1-<br>230 | 1500       | 16              | 14           | 6        | 115  | 90*   | 390 |
| Sanifos 610 2 GR SP S RD |           |            |                 |              |          |  | 160   | 400 |
| Sanifos 610 2 VX SP S    | 1-<br>230 | 1500       | 23              | 14           | 6        | 115  | 160   | 390 |
| Sanifos 610 2 VX SP S RD |           |            |                 |              |          |  | 160   | 400 |
| Sanifos 610 2 VX SP T    | 3-<br>400 | 2800       | 28              | 16,7         | 6        | 115  | 160   | 390 |
| Sanifos 610 2 VX SP T RD |           |            |                 |              |          |  | 160   | 400 |

**C D**

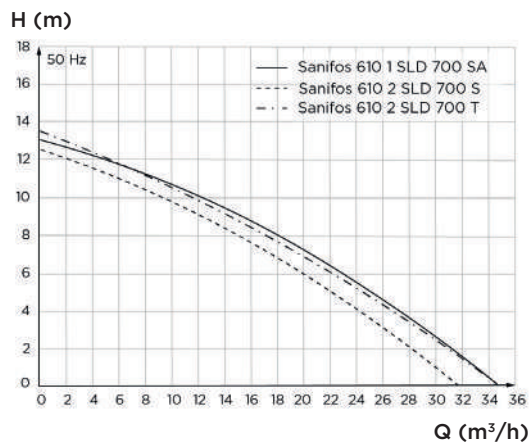

|                            | ~<br>(V)  | P 1<br>(W) | Q max<br>(m³/h) | H max<br>(m) | I<br>(A) | <br>(kg) | Niveau - Level - Stand-<br>Nivel - Livello - Nivel<br>(mm) ±10 mm |     |
|----------------------------|-----------|------------|-----------------|--------------|----------|---|---|-----|
|                            |           |            |                 |              |          |   | OFF   | ON  |
| Sanifos 610 1 SLD 700 SA   | 1-<br>230 | 1100       | 35              | 13,5         | 9,2      | 85  | 140 min.  | 500 |
| Sanifos 610 2 SLD 700 S    | 1-<br>230 | 1100       | 32              | 13           | 9,2      | 120   | 150   | 400 |
| Sanifos 610 2 SLD 700 S RD |           |            |                 |              |          |   | 160   | 400 |
| Sanifos 610 2 SLD 700 T    | 3-<br>400 | 1100       | 35              | 13,7         | 6        | 120   | 150   | 400 |
| Sanifos 610 2 SLD 700 T RD |           |            |                 |              |          |   | 160   | 400 |

\* avec délai retard, with stop delay, mit Pumpennachlaufzeit, con tiempo de retraso, con tempo di ritardo, met pompvertraging, com tempo de atraso

# SANIFOS 1300

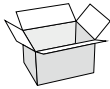

Étendue de la fourniture - Scope of supply- Lieferumfang - Elementes suministrados - Oggetto della fornitura - Âmbito do fornecimento - Leveringsomvang - Zakres dostawy - Leveransens innehåll - Lista de piese furnizate - A szállított alkatrészek listája - Kiện hàng

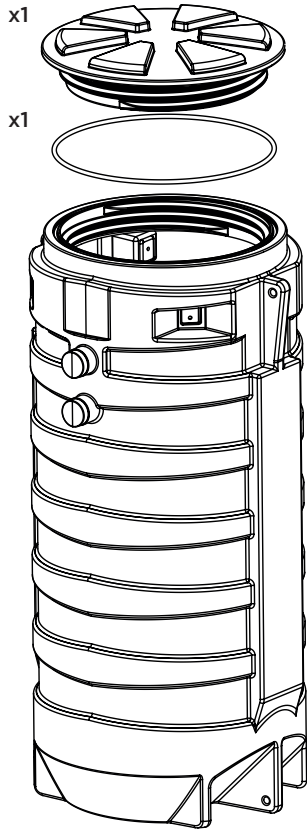

## A Sanipump GR/ Sanipump VX

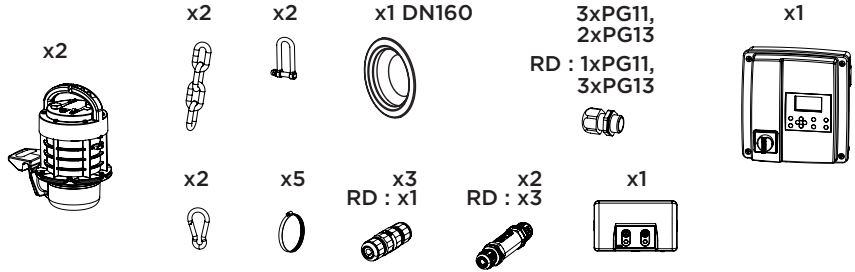

+ hydraulique pré-montée, rail, flotteur(s) - with pre-assembled hydraulic, stainless steel guide bars and float(s) - vormontierte Hydraulik, Führungsschienen aus Edelstahl, Schwimmer(n) - Accesorios hidráulicos preinstalados, barras de guía, flotador(es) - Sistema hidráulico pré-montado, barras de guia inox, flutuador(es) - Hydraulica voorge-monteerd, geleiderail en vlotter - Idraulica premontata, barre di guida, galleggianti(i)

## B Sanisub Steel

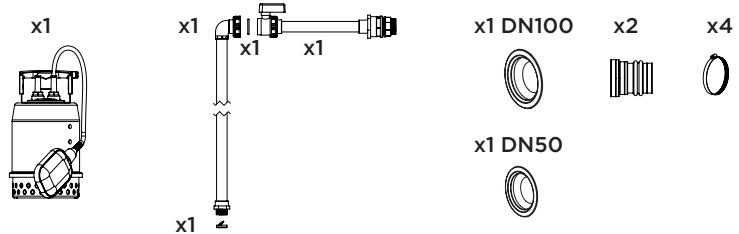

Caractéristiques techniques - Technical data - Technische Daten - Datos técnicos - Caratteristiche tecniche - Dados técnicos - Technische gegevens - Technické údaje - Informacje techniczne - Tehniska data - Date tehnice - Műszaki adatok - Thông số kỹ thuật

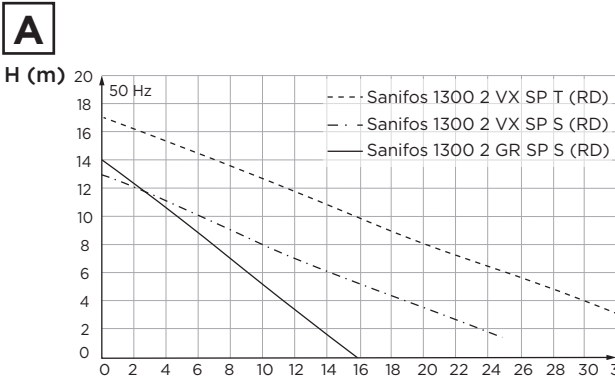

|                    | ~<br>(V) | P 1<br>(W) | Q max<br>(m³/h) | H max<br>(m) | l<br>(A) | Kg<br>(kg) | Niveau - Level<br>- Stand- Nivel<br>- Livello -<br>Nível<br>(mm) ±10 mm |     |
|--------------------|----------|------------|-----------------|--------------|----------|------------|---|-----|
|                    |          |            |                 |              |          |            | OFF   | ON  |
| 2 Sanipump GR S    | 1-       | 1500       | 16              | 14           | 6        | 138        | 200   | 600 |
| 2 Sanipump GR S RD | 230      |            |                 |              |          |            |   |     |
| 2 Sanipump VX S    | 1-       | 1500       | 25              | 13           | 6        | 138        | 200   | 600 |
| 2 Sanipump VX S RD | 230      |            |                 |              |          |            |   |     |
| 2 Sanipump VX T    | 3-       | 2800       | 33              | 17           | 7        | 138        | 200   | 600 |
| 2 Sanipump VX T RD | 400      |            |                 |              |          |            |   |     |

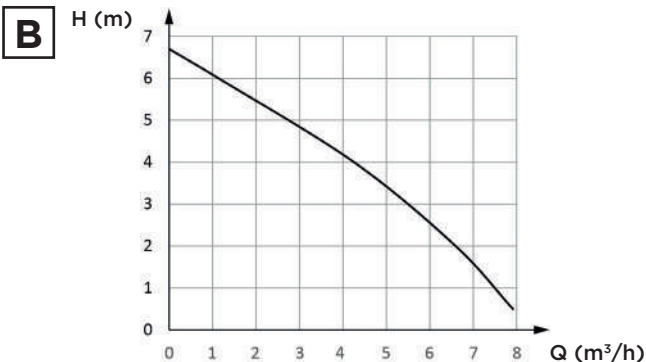

|                 | ~<br>(V) | P 1<br>(W) | Q max<br>(m³/h) | H max<br>(m) | l<br>(A) | Kg<br>(kg) | Niveau - Level<br>- Stand- Nivel<br>- Livello -<br>Nível<br>(mm) ±10 mm |     |
|-----------------|----------|------------|-----------------|--------------|----------|------------|---|-----|
|                 |          |            |                 |              |          |            | OFF   | ON  |
| 1 Sanisub Steel | 230      | 450        | 8               | 7            | 2        | 90         | 140   | 360 |

